

# TRI-X PLUS

## 45 mm Monolith Panel Base System

Slim 45 mm Panel Base System is a monolith frame concept in full aluminium extrusions. Profiles are aluminium extruded and the partitions can be used as a stand alone system with full configurations possibilities.





Tri-X Plus

## EXECUTIVE WORKSTATION

### When Pragmatic Applies

Tri-X Plus system can be layout into cluster of executive workstation for semi-enclosed workspace. The pinable fabric panel with accessories tile helps to present a neat and tidy working area. By having a socket above the table top, facilitate people to accommodate for electrification purpose. A combination of MFC wooden filling pedestal effectively offers storage close at hand.

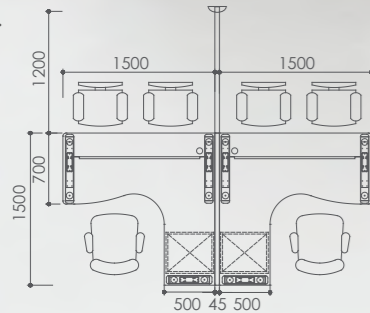

Tri-X Plus & Maxim-A

## HYBRID SYSTEM

### Total Rationality & Harmony of Ideas

This is a complete and integrated system, flexible with a strong technological personality. It boasts a very clean design and which is easy to assemble, in total compliance of Maxim-A and Tri-X Plus mix and match concept.

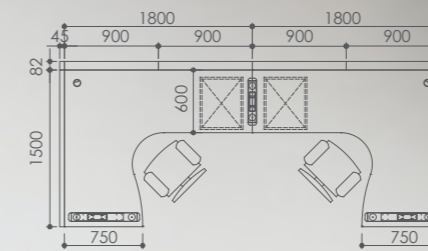



Tri-X Plus

## WIRE MANAGEMENT

Tri-X Plus panels come with built in internal risers for wire management but carry limited wiring capacity. Outlets for power and voice/data are mounted on power panels above table top, underneath table top or bottom raceway positions.

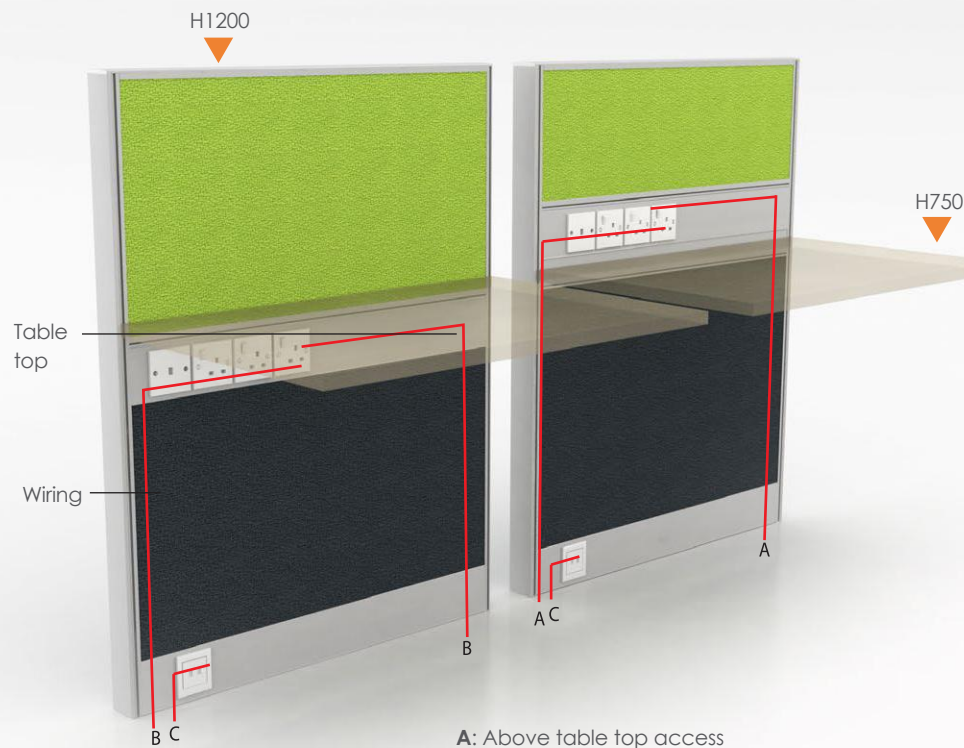

**A:** Above table top access  
**B:** Underneath table top access  
**C:** Bottom raceway access

Connectors:

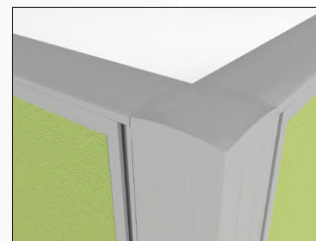

2 - way connector

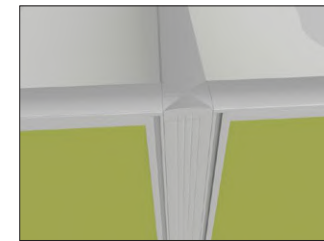

3 - way connector

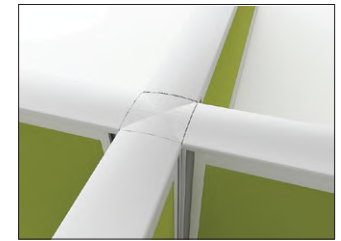

4 - way connector

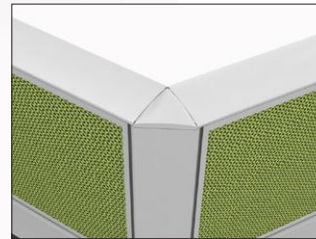

120 - degree 2 way connector

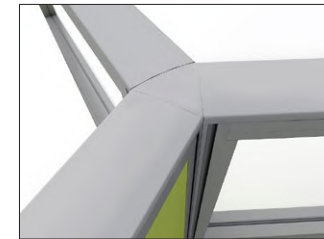

120 - degree 3 way connector



End cap - Aluminium die-cast